

SPECIFICATIONS

Sensor head				Amplifier		
Model	BS-30T	BS-05T	BS-02T	Model	BS-V	BS-A
Field of view	ø30/500mm	ø5/100mm	ø2/50mm	Measuring range	0 to 500°C	
Optics	Silicon lens			Display range	-20 to 520°C	
Sensing element/Wavelength	Thermopile/8 to 14µm			Response time	500msec./90%	
Sighting method	N/A		Coaxial laser marker (Class 2)	Accuracy (± 1.0)	±1% of reading value or ±2°C whichever is greater	
Ambient temperature	0 to 65°C (0 to 150°C; with optional cooling jacket)		0 to 50°C	Repeatability	±1°C of reading value	
Environmental humidity	35 to 85%RH (without dew condensation)			Display resolution	1°C	
Storage temperature	-20 to 70°C			Analog output	1mV/°C	4 — 20mA
Vibration resistance	3G (20 — 50Hz, in accordance with JIS C0911)			Output resolution	0.2°C	
Water resistance	IP67			Emissivity ratio (ε) adjustment	0.10 to 1.20 (0.01/1 step)	
Weight	300g		400g	Delay setting	1 (0.5sec) to 200 (approx. 10sec) variable	
Optional accessories	Refer to the Optional Accessory Table of the previous page			Power supply/Current consumption	DC12 — 24V±10%/Max 100mA	
				Ambient temperature	0 to 50°C	
				Environmental humidity	35 to 85%RH (without dew condensation)	
				Storage temperature	-20 to 60°C	
				Vibration resistance	3G (20 — 50Hz, in accordance with JIS C0911)	
				Water resistance	IP65	
				Weight	320g	
				Standard accessories	Fixture x 1, M4 screw x 2	

* A sensor and an amplifier form one complete set.
 They do not function individually.
 * Specifications may change without prior notice.

DIMENSIONS

Sensor Head
 BS-30T/BS-05T

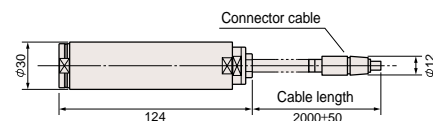

BS-02T

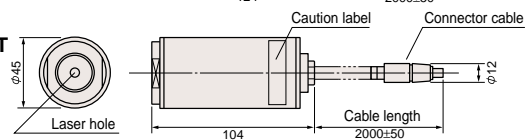

Air/Water Cooling Jacket (option)

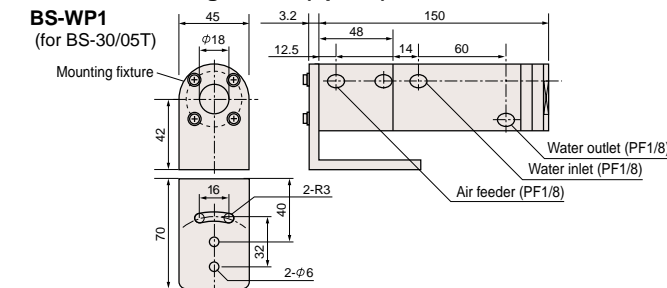

[Unit: mm]

Amplifier
 BS-A/BS-V

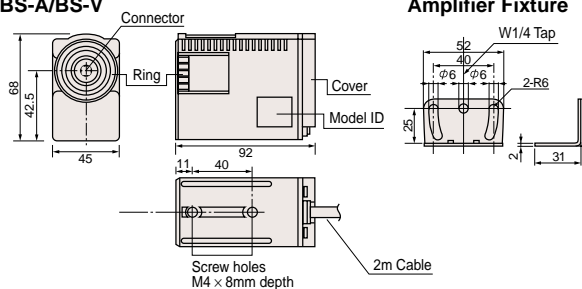

Sensor Mounting Bracket (option)

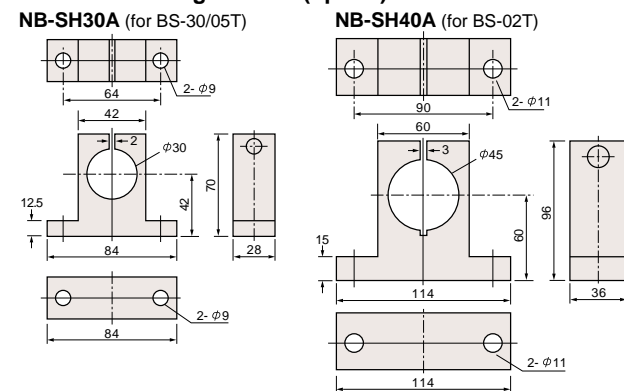

Safety Guidelines



CAUTION
 DO NOT STARE INTO BEAM
 LASER DIODE POWER MAX1.0mW
 WAVELENGTH 650nm
 CLASS 2 LASER PRODUCT

BS-02T is Class 2 laser products.

Products mentioned in this catalogue are equipped with Class 2 laser.
 In case of re-export to foreign countries, please confirm the relevant regulation for laser products in the destination country.

- WARNING** Do not look into the laser nor direct it toward the eyes. Even the reflection is harmful. Laser may cause eye injury or damage your health.
- CAUTION** This product is not a clinical thermometer; therefore, it cannot be used for medical purposes.

Environmental Warnings

- KEEP THE THERMOMETER AWAY FROM DIRECT SUNLIGHT, DUST, HIGH TEMPERATURES AND HIGH HUMIDITY WHILE IN USE AND STORAGE. This may cause irreparable damage or incorrect measurement.
- DO NOT EXPOSE THE THERMOMETER TO SUDDEN TEMPERATURE CHANGES. Sudden temperature change of the environment may cause incorrect measurement. In such cases, wait until the thermometer reaches steady temperature before taking measurement.
- KEEP THE THERMOMETER AWAY FROM STRONG ELECTROMAGNETIC SOURCES, CORROSIVE OR EXPLOSIVE GASES. This may cause irreparable damage or incorrect measurement.

Usage Warnings

- AVOID MEASURING SHINY SURFACES. Shiny surfaces reflect radiation from surrounding objects. Although the emissivity ratio can be adjusted to compensate for this problem, accurate measurement is difficult.
- USE THE CORRECT VOLTAGE. Applying voltages other than 12-24VDC may cause short-circuit, damages, fire or injury. In such cases, turn the power off immediately.
- DO NOT LET THE THERMOMETER TOUCH THE OBJECTS THAT IS BEING MEASURED. The unit is a non-contact thermometer. Touching or getting too close to the objects with high temperatures may cause irreparable damage or incorrect measurement.
- DO NOT TOUCH THE LENS. Do not touch the lens with anything hard or things with sharp points, which may damage the lens. A damaged lens causes incorrect measurement.
- KEEP THE THERMOMETER AWAY FROM CHARGED OBJECTS. This may cause irreparable damage or incorrect measurement.

Separate Sensor for Flexible Installation

3 Different Sensor Models for Standard Focus, Narrow Focus and Fine Spot Measurement

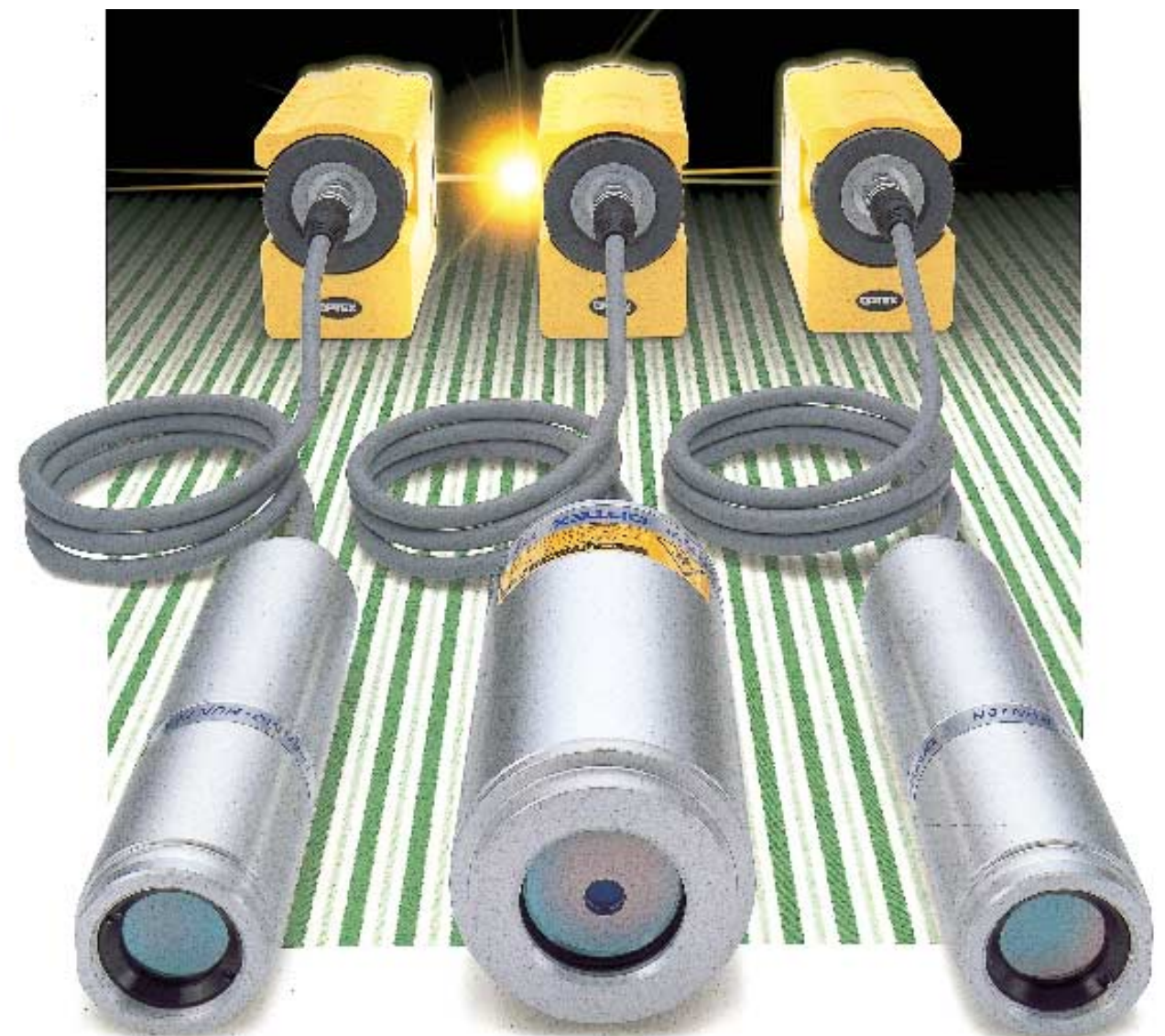

- Measuring range: 0 to 500°C
- Quick response: 500msec
- Amplifier unit with integrated digital display
- ε-TEACH function for easy emissivity adjustment
- Analog output: 4—20mA or 1mV/°C

- BS-30T Sensor
- BS-05T Sensor
- BS-02T Sensor
- BS-A Amplifier
- BS-V Amplifier

Note: A sensor and an amplifier form one complete set. They do not function individually.



3 Types Of Field Of View Covers A Wide Range Of Applications

The BS Series are non-contact thermometers with separate sensor and amplifier units. The connector cable can be extended with optional cable. The TEACH function that simplifies emissivity adjustment and the integrated display unit of amplifiers make operation so much easier. You can choose from 3 types of sensor and 2 amplifier units along with a wide variety of optional parts to match your requirements. OPTEX is the answer to your special needs.

Standard Focus Type BS-30T

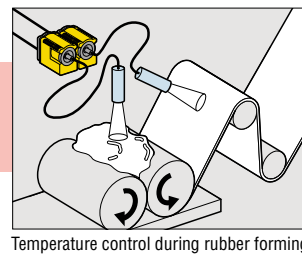
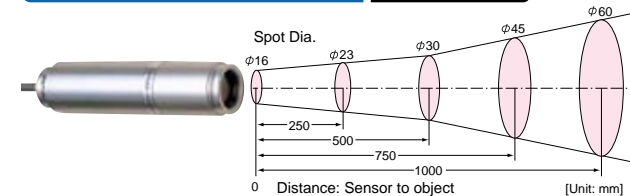

Temperature control during rubber forming

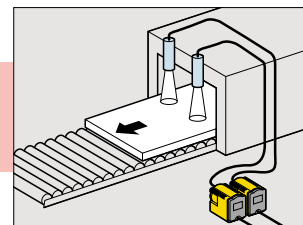

Temperature measurement of painted surface

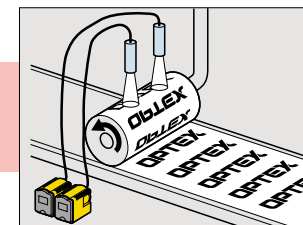

Temperature monitoring of a printing roller

Narrow Focus Type BS-05T

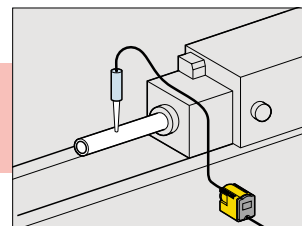
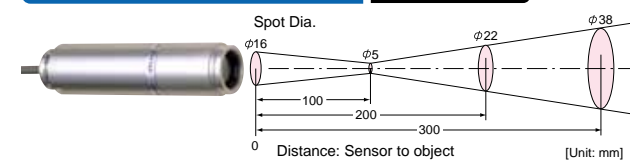

Temperature check in rubber hose manufacturing

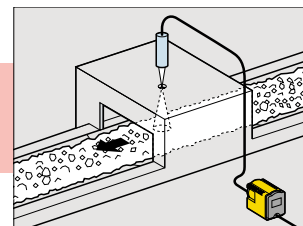

Overheating check of coal

Fine Spot Type BS-02T

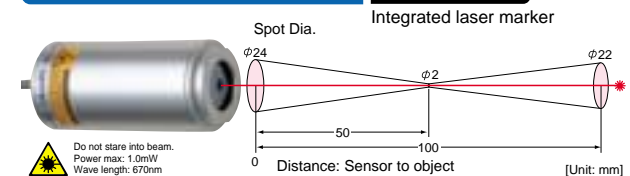

Remarks
The optical resolution values stated in "Field of View" are at 90% energy. The size of the target object should be sufficiently larger than the field of view (spot size) shown in the above illustration. Especially, the fine spot type BS-02T requires the target object should be approx. 1.5 times larger than the spot size.

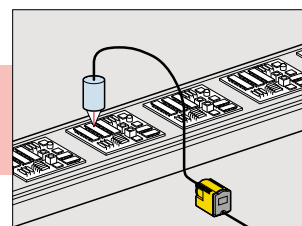

Abnormal heating check of printed boards

8m Extension Cable BS-EC8

Just as the 2m cable that comes with all sensor models, this 8m cable can also withstand heat up to 150°C. 10m cable length gives enough room for all the twists and turns to make installation easier.



Sensor Mounting Bracket

- NB-SH30A (BS-30T/BS-05T)
- NB-SH40A (BS-02T)



Sensor mounting brackets are different in size. Please refer to the DIMENSIONS on the back cover.

Optional Accessory Table

Sensor	BS-30T	BS-05T	BS-02T
BS-EC8	●	●	●
BS-WP1	●	●	N/A
NB-SH30A	●	●	N/A
NB-SH40A	N/A	N/A	●

Air Purge/Water Cooling Jacket BS-WP1 (BS-30T/BS-05T)

Use of an air purge/water cooling jacket significantly improves sensor's ability to operate in various environment.

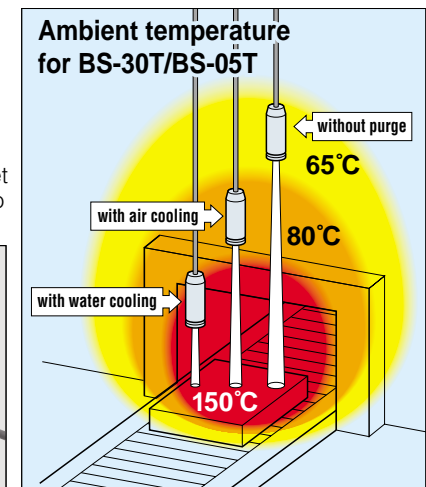
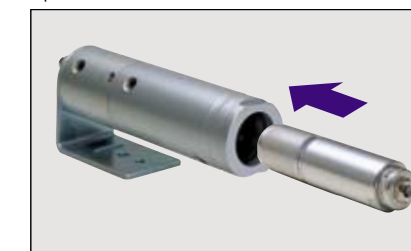

Water cooling

Water cooling only. Air purge can be used simultaneously for blowing dust away.

Ambient temperature: up to 150°C
Water flow: 0.5 to 2l/min
Water temperature: 30°C or less
Water pressure: 1kgf/cm² or less

Air cooling

Blown air also removes dust from the lens, besides cooling.

Ambient temperature: up to 80°C
Air flow: 50 to 150 Nl/min
Air temperature: 20°C
Air pressure: 2kgf/cm²

(Option) Black Tape HB-250



Hint for accurate measurement

The black tape (HB-250) is designed for more accurate measurement especially if the target object has a shiny surface. Apply HB-250 on the surface of the target and measure the area covered by HB-250 with emissivity setting at 0.95.

- Dimensions 60mm x 2000mm
- Withstand heat up to 250°C



BS-A/BS-V

TEACH Function Simplifies Emissivity Adjustment

Enter the temperature measured by a contact-type thermometer (thermocouples, etc.) just once and the rest is automatic. The unit calculates the emissivity ratio (ε) and memorizes the result. (You may also manually adjust emissivity ratio)

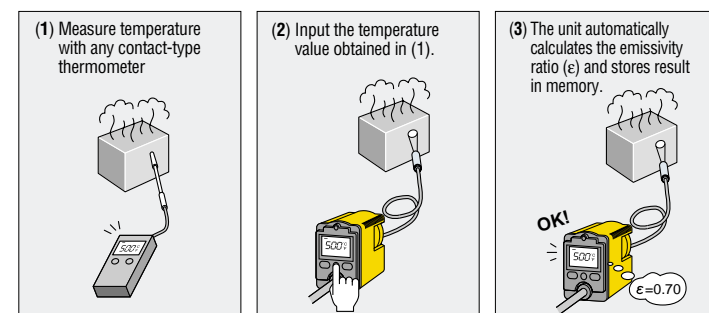

Integrated Digital Display

The large and easy-to-see integrated digital display on the amplifier unit makes remote operation easy.

2 Types of Analog Output

Choose one of 2 types of amplifier unit, the current output type BS-A (4—20mA) and the voltage output type BS-V (1mV/°C) whichever suits your control device.

- "Down" button
- "C/F mode (BS-A only)
- Delay set adjustment
- Enter key and On/Off switch for laser
- Emissivity ratio (ε) adjustment (manual method)
- Emissivity ratio (ε) adjustment (TEACH function)
- "Up" button
- Measurement mode